

# -Studio-

# (10BR60)

## LOW FREQUENCY

This 10" bass and mid bass loudspeaker has been specifically designed to deliver exceptional low and mid frequency reproduction, with high sensitivity and extremely low distortion. It incorporates a curvilinear cone attached to a rubber surround, in order to provide suspension stability and to allow maximum excursion linearity. By combining a powerful magnet construction with a cast aluminium basket, this model achieves high power capacity, and consequently, contributes to reduce the thermal power compression.

Modelo de 10" de bajas y medias frecuencias. Utiliza un cono curvilineo con el fin de obtener una respuesta lineal, unido a una suspensión de goma sintética para evitar los problemas inherentes a las tradicionales suspensiones de espuma de poliuretano, sujetas a un envejecimiento muy marcado y con unas características mecánicas inestables. Esto se traduce en una respuesta impulsional muy rápida y unas variaciones insignificantes de los parámetros del altavoz con el transcurso del tiempo, lo que redonda en unos graves nitidos y profundos, de gran impacto, y unos medios naturales y de gran definición.



PREDICTED LOW FREQUENCY RESPONSE • Bass-reflex cabinet, Vb=40 l, fb=38 Hz

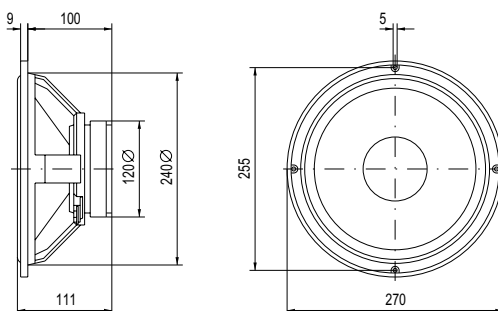
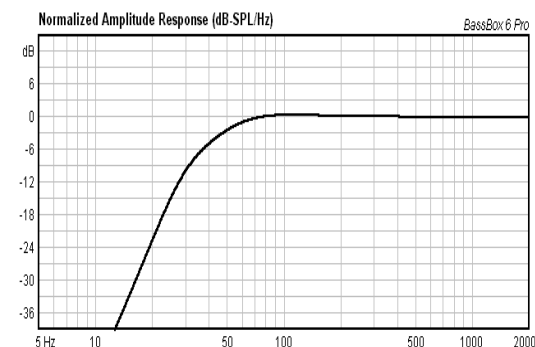

### SPECIFICATIONS

Nominal diameter	250 mm. - 10 in.
Rated impedance	8 ohms
Power capacity*	100 w RMS
Program Power	200 w
Sensitivity	91.5 dB 2.83 v @ 1 m @ 2π
Frequency range	30 - 5000 Hz
Recom. enclosure vol.	30 - 100 l 1.06 / 3.53 ft. <sup>3</sup>
Voice coil diameter	52 mm. - 2 in.
Magnetic assembly weight	2.75 kg 6.1 lb
BL Factor	12.4 N/A
Moving mass	0.050 kg
Voice coil length	16 mm.
Air gap height	7 mm.
X damage (peak to peak)	30 mm.

### MOUNTING INFORMATION

Overall diameter	270 mm / 10.62 in
Bolt circle diameter	255 mm / 10.03 in
Baffle cutout diameter	
Front mount	240 mm / 9.44 in
Rear mount	230 mm / 9.05 in
Depth	111 mm / 4.37 in
Volume displaced by driver	2.5 l / 0.08 ft. <sup>3</sup>
Net weight	2.9 kg / 6.38 lb
Shipping weight	3.4 kg / 7.48 lb

### MATERIALS

Basket	Die Cast aluminium
Cone	Paper
Surround	Rubber
Voice coil	Copper
Magnet	Ferrite

FREQUENCY RESPONSE & DISTORTION CURVES, MAGN. On axis, 1w @ 1m.

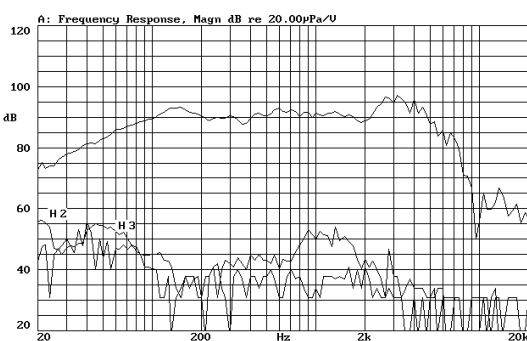

TIME RESPONSE, MAGN.

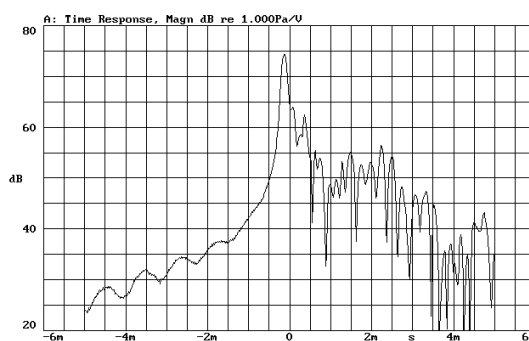

FREQUENCY RESPONSE, PHASE. On axis, 1w @ 1m.

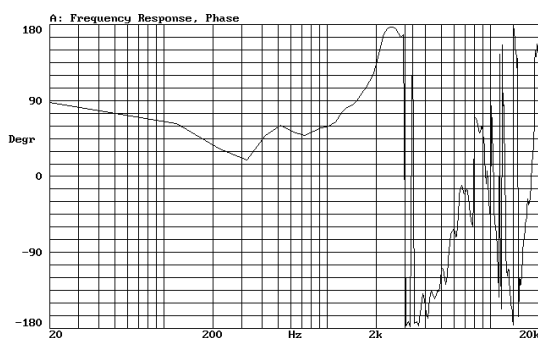

FREE AIR IMPEDANCE CURVE

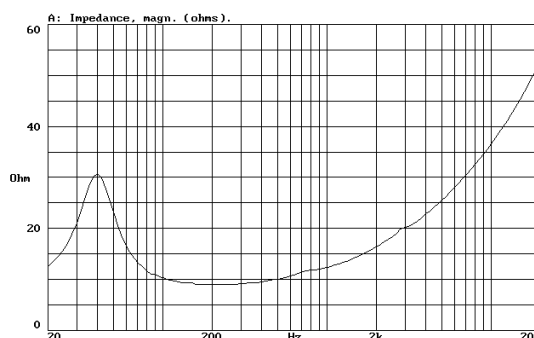

### THIELE-SMALL PARAMETERS\*\*

Resonant Frequency, fs	45 Hz
D.C. Voice Coil Resistance, Re	6.5 ohms.
Mechanical Quality Factor, Qms	1.9
Electrical Quality Factor, Qes	0.62
Total Quality Factor, Qts	0.47
Equivalent Air Volume to Cms, Vas	47 l
Mechanical Compliance, Cms	230 μm/N
Mechanical Resistance, Rms	5.1 kg/s
Efficiency, ηo (%)	0.75 %
Effective Surface Area, Sd(m <sup>2</sup> )	0.038 m <sup>2</sup>
Maximum Displacement, Xmax	6 mm
Displacement Volume, Vd	240 cm. <sup>3</sup>
Voice Coil Inductance, Le @ 1kHz	1.1 mH

VOICE COIL INDUCTANCE CURVE

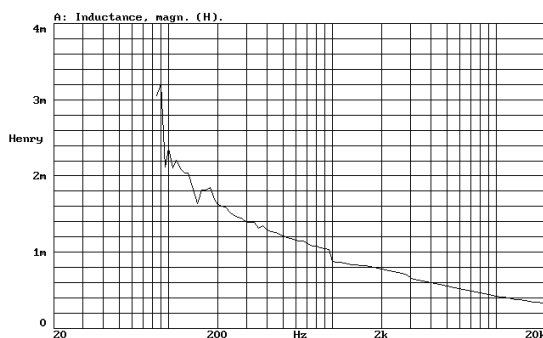

Re + Red(w) CURVE

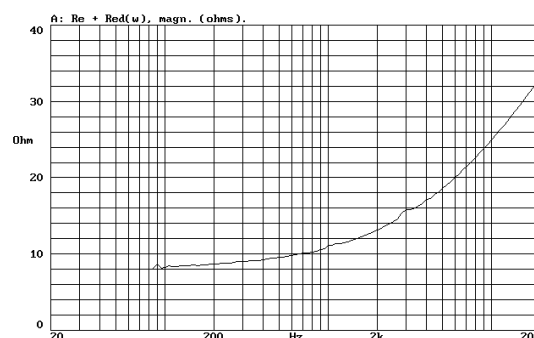

### NOTES

\*The power capacity corresponds to the RMS maximum value that can dissipate the loudspeaker when a sinus signal is applied for a period of at least two hours. Program power is defined as the transducer's ability to handle normal music program material.

\*\* T-S parameters are measured after an exercise period using a preconditioning power test, using a velocity-current laser transducer, and will reflect the long term parameters, once the loudspeaker has been working for a short period of time.

### NOTAS

\*La potencia admisible corresponde a la máxima potencia RMS que puede disipar el altavoz durante al menos dos horas, cuando se le aplica una señal senoidal determinada. Por potencia programa se entiende la capacidad del altavoz en el manejo de señales transitorias, como sería el proporcionado por el contenido de un pasaje musical normal.

\*\* Los parámetros T-S han sido medidos después de un periodo de fatiga y estabilización de las suspensiones, mediante transductor laser de velocidad-corriente, y son el reflejo de los parámetros a largo plazo del altavoz, una vez éste haya sido instalado y haya trabajado en un corto espacio de tiempo.